

# NYFORS

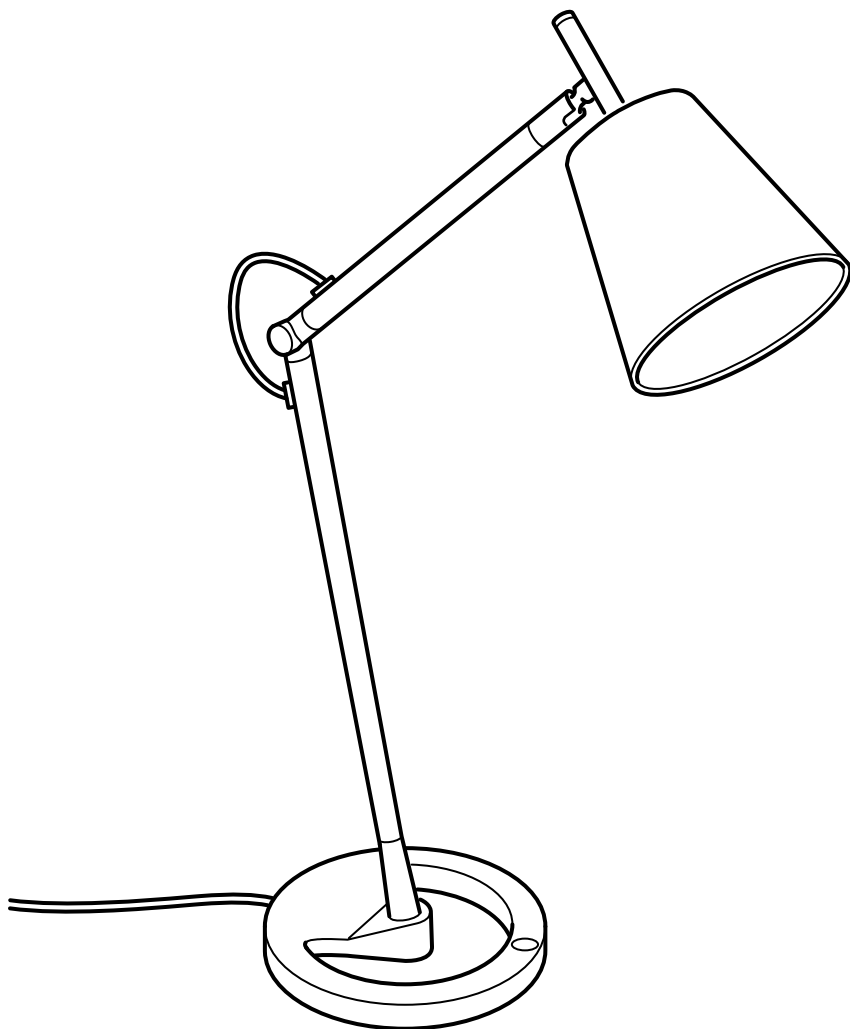

Design and Quality  
IKEA of Sweden



ENGLISH

# IMPORTANT SAFETY INSTRUCTIONS

This product has a polarized plug (one blade is wider than the other) as a feature to reduce the risk of electric shock. This plug will fit in a polarized outlet only one way. If the plug does not fit fully in the outlet, reverse the plug. If it still does not fit, contact a qualified electrician. Never use with an extension cord unless plug can be fully inserted. Do not attempt to defeat the safety purpose of the polarized attachment plug. Do not alter the plug.

## CAUTION:

TO PREVENT ELECTRICAL SHOCK,  
MATCH WIDE BLADE OF PLUG TO  
WIDE SLOT, FULLY INSERT.

ENGLISH

This device complies with part 15 of the FCC Rules. Operation is subjected to the following two conditions:

1. This device may not cause harmful interference, and
2. this device must accept any interference received, including interference that may cause undesired operation.

## WARNING

Changes or modifications not expressly approved by the party responsible for compliance could void the user's authority to operate the equipment.

ENGLISH

## WARNING

Deviation from the assembly instructions may result in a risk of fire or electric shock.



**FRANÇAIS**

# CONSIGNES DE SÉCURITÉ IMPORTANTES

Ce produit est muni d'une fiche polarisée (une lame est plus large que l'autre). Pour des raisons de sécurité, cette fiche ne s'insère que d'une seule façon dans la prise polarisée. Si la fiche ne s'insère pas complètement dans la prise, inverser la fiche. Si vous n'arrivez toujours pas à insérer la fiche dans la prise, consultez un électricien qualifié. Ne jamais utiliser un fil de rallonge à moins que la fiche ne puisse être insérée complètement. Ne jamais tenter de déjouer le dispositif de sécurité de la fiche. Ne jamais modifier la fiche.

**AVERTISSEMENT:**  
POUR EVITER TOUT RISQUE DE  
CHOC ELECTRIQUE, INTRODUIRE  
LA FICHE LARGE DANS LA FENTE  
LARGE DE LA PRISE DE COURANT  
EN S'ASSURANT QU'ELLE S'INSERE  
COMPLETEMENT.

**FRANÇAIS**

Cet appareil est conforme à la partie 15 des règles de la FCC. Son fonctionnement est soumis aux deux conditions suivantes:

1. Cet appareil ne doit pas provoquer de brouillage préjudiciable et
2. il doit accepter tout brouillage reçu, y compris le brouillage pouvant entraîner un mauvais fonctionnement.

## ATTENTION:

Tout changement apporté à cet appareil non expressément approuvé par la partie responsable de la conformité est susceptible d'annuler le droit de l'utilisateur à se servir de cet équipement.

**FRANÇAIS**

## ATTENTION

Tout écart par rapport aux instructions d'assemblage peut entraîner un risque d'incendie ou de choc électrique.



ESPAÑOL

# INSTRUCCIONES IMPORTANTES DE SEGURIDAD

Este producto tiene un enchufe polarizado (una patilla es más ancha que la otra) para reducir el riesgo de calambres. Este enchufe sólo se podrá enchufar de una forma. Si el enchufe no se puede introducir completamente en la toma, gíralo. Si sigue sin poderse enchufar, contactar con un electricista cualificado. Nunca se debe usar un alargador si el enchufe no se puede enchufar de forma correcta. Nunca se debe alterar el dispositivo de seguridad del alargador polarizado. No manipular el enchufe.

## ADVERTENCIA:

PARA EVITAR CALAMBRES, LA PATILLA ANCHA DEL ENCHUFE DEBE COINCIDIR CON LA RANURA ANCHA E INTRODUCIRSE COMPLETAMENTE.

ESPAÑOL

Este aparato cumple la parte 15 de las normas FCC. Su funcionamiento está sujeto a las dos condiciones siguientes:

1. Este aparato no debe provocar interferencias perjudiciales.
2. Debe aceptar cualquier interferencia que reciba, incluidas las interferencias que puedan suponer un mal funcionamiento.

## ATENCIÓN:

Cualquier cambio o modificación que se realice sin ser aprobado expresamente por la parte responsable de la conformidad, es susceptible de anular el derecho del usuario a utilizar este equipo.

ESPAÑOL

## ADVERTENCIA

No seguir las instrucciones de montaje puede resultar en incendio o descarga eléctrica.

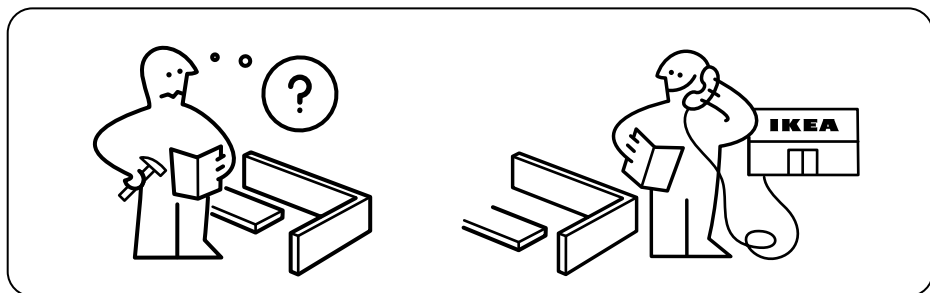

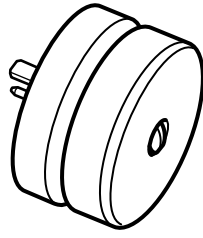

146707

1x

**1**

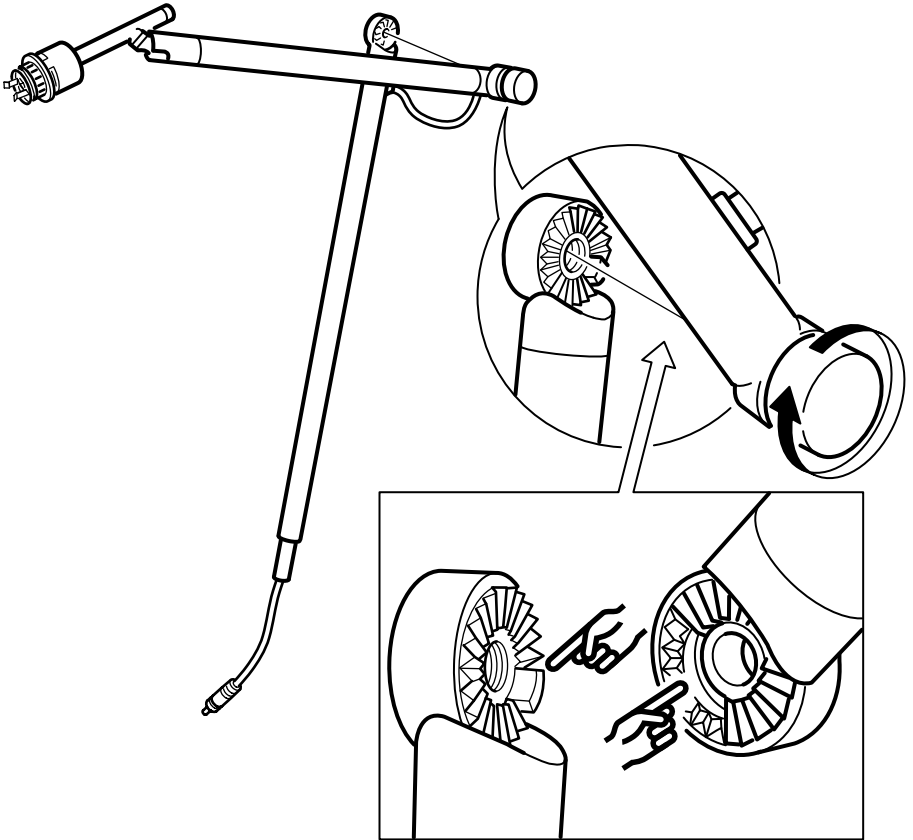

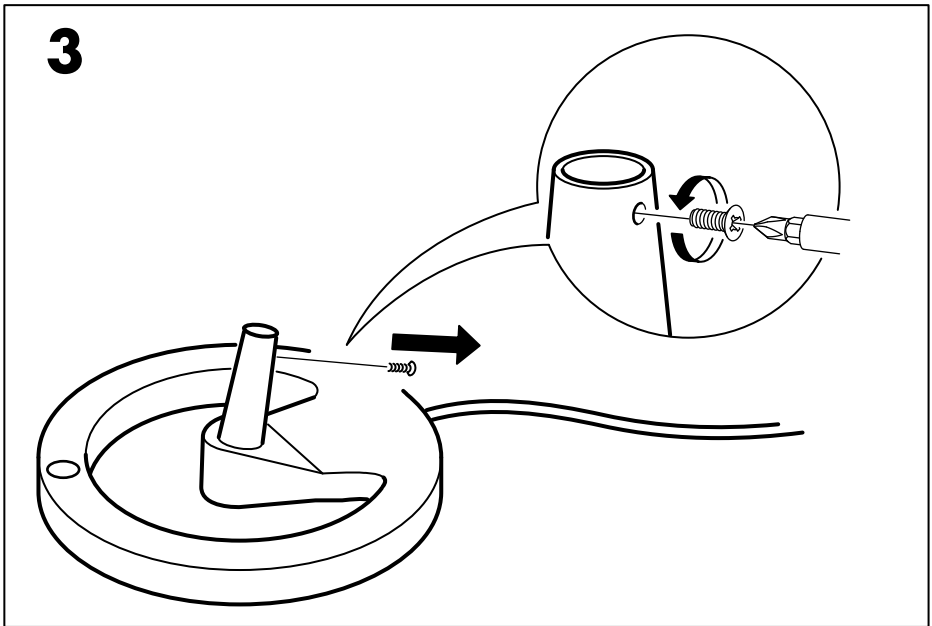
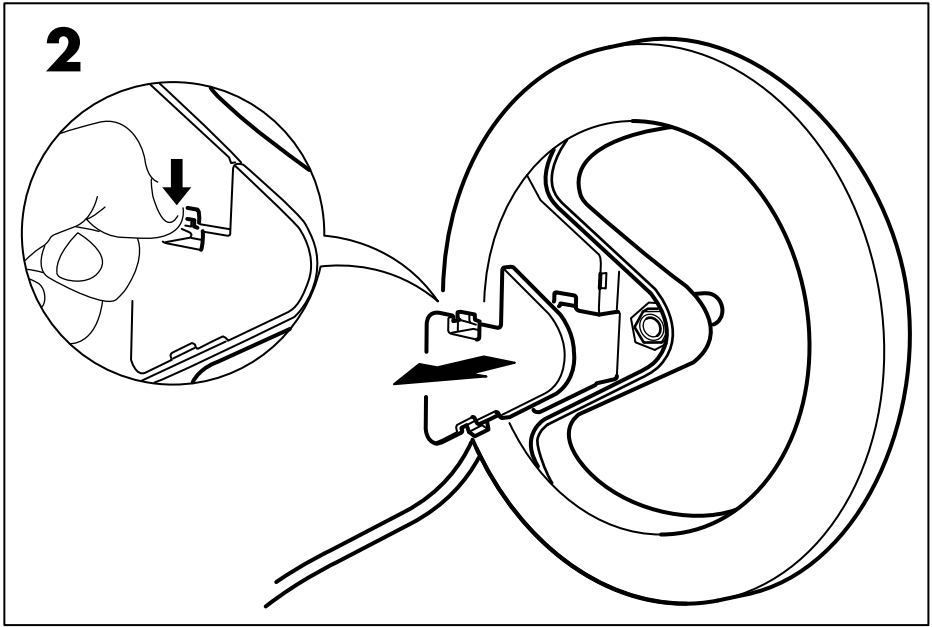

4

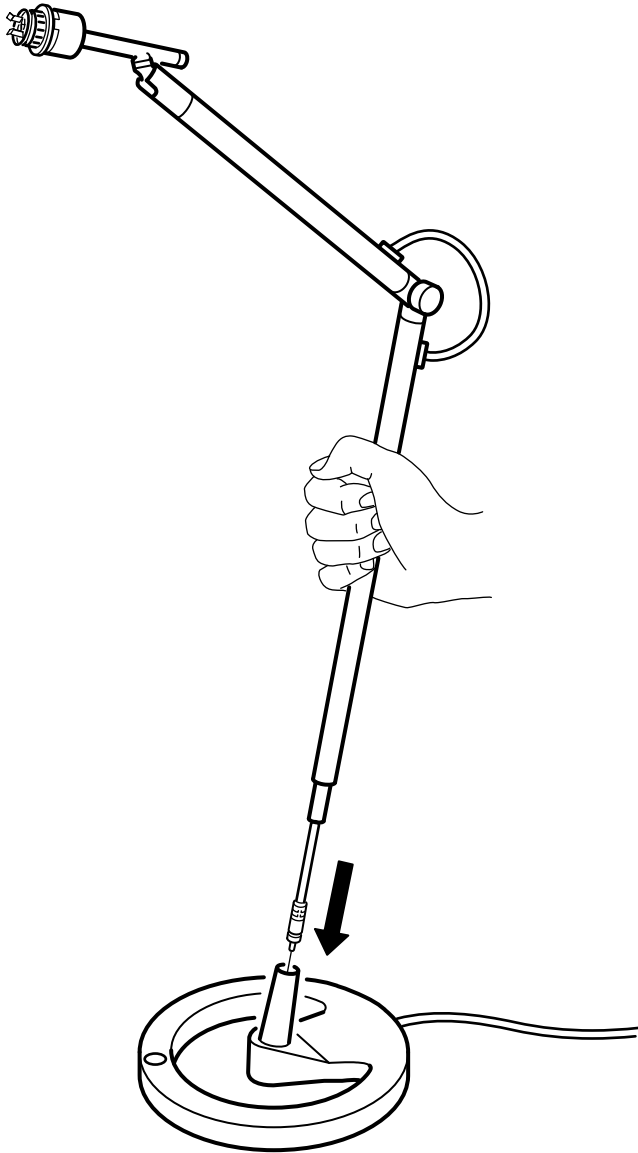

**5**

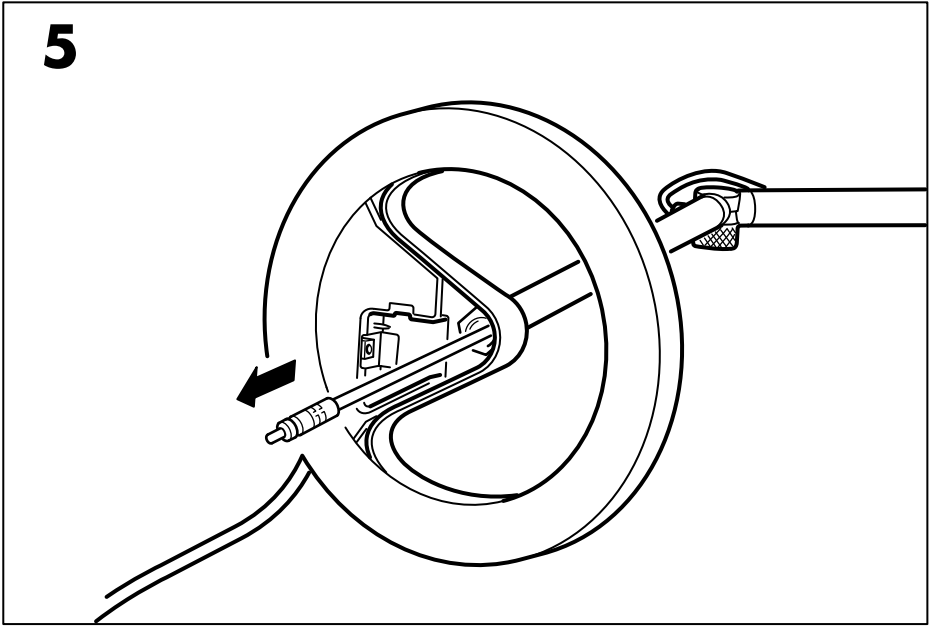

**6**

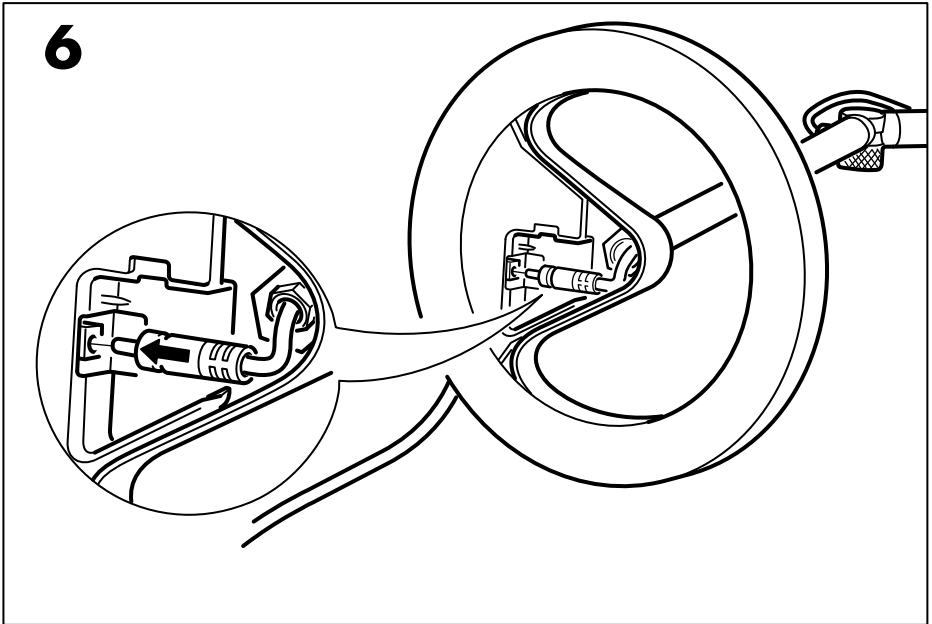



**7**

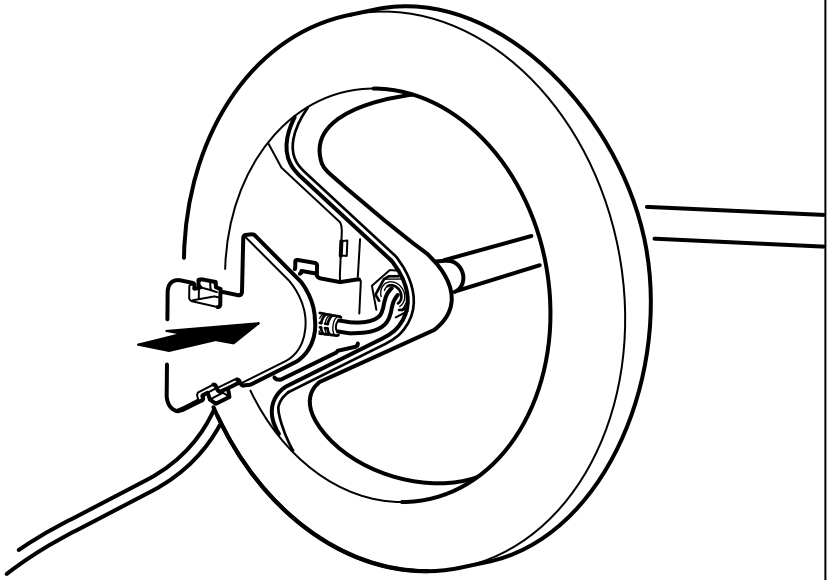

8

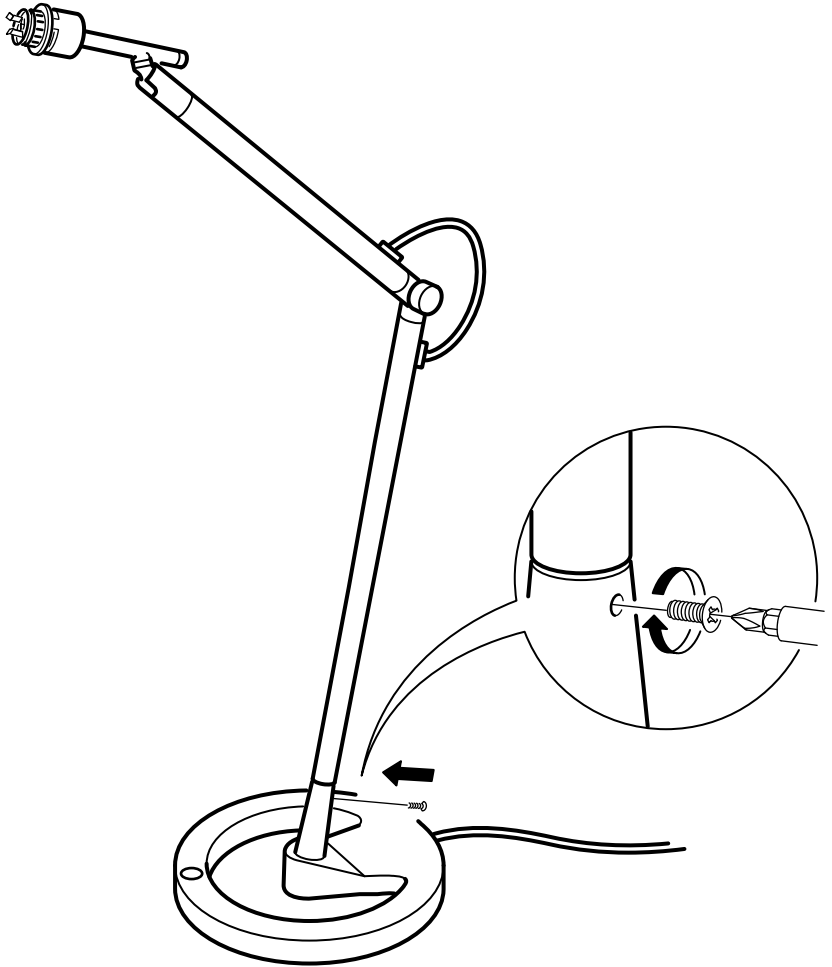

9

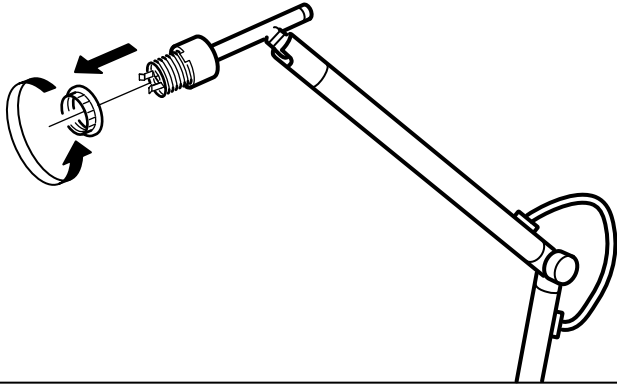

10

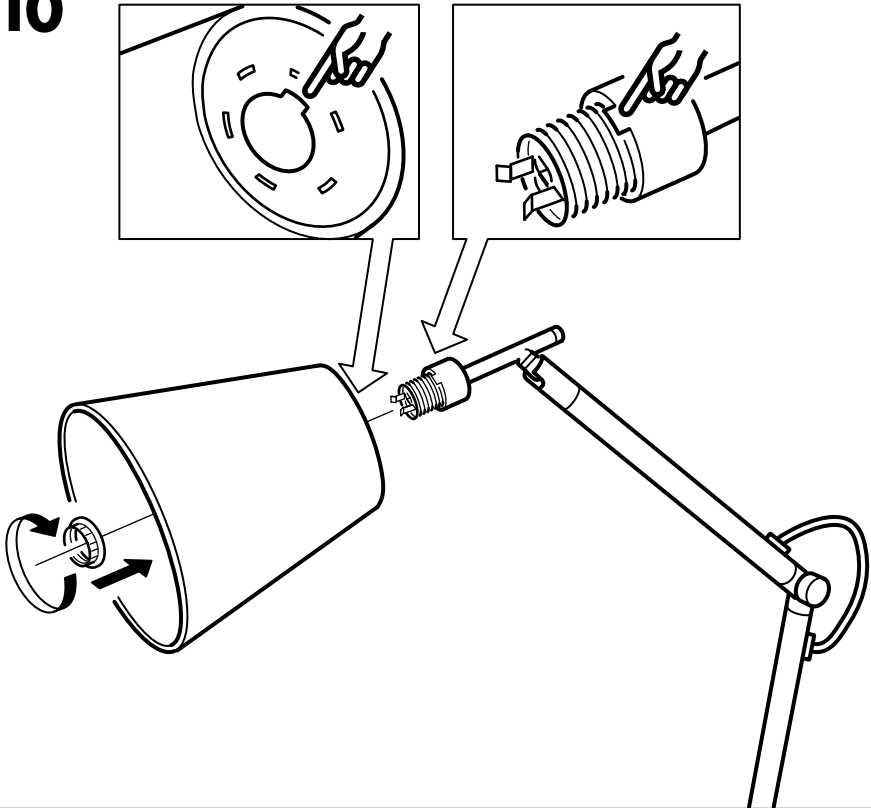

11

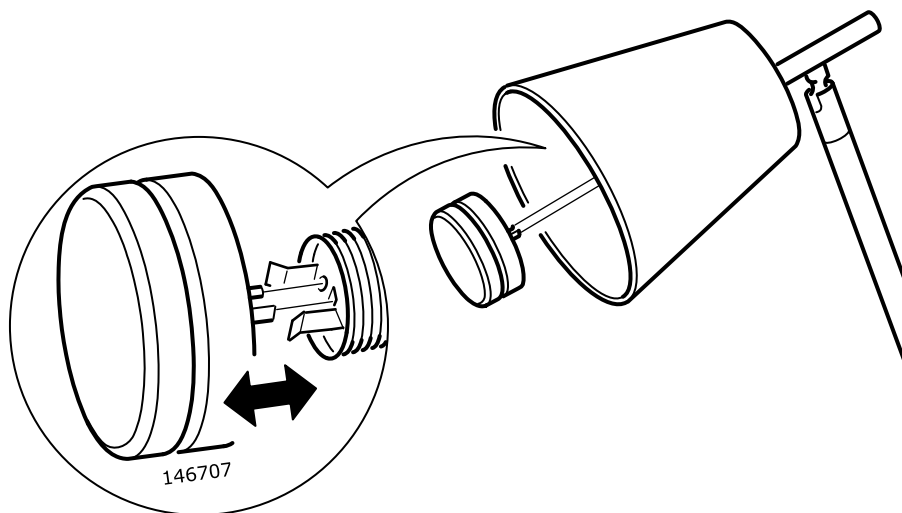

**ENGLISH**

WHEN CHANGING BULB - use only  
GUZ 5.3 LED bulb.

**FRANÇAIS**

REPLACEMENT DE L'AMPOULE -  
utiliser uniquement une ampoule à  
LED GUZ 5.3.

**ESPAÑOL**

CUANDO CAMBIES LA BOMBILLA:  
utiliza solo la bombilla GUZ 5.3 LED.

**12**

